

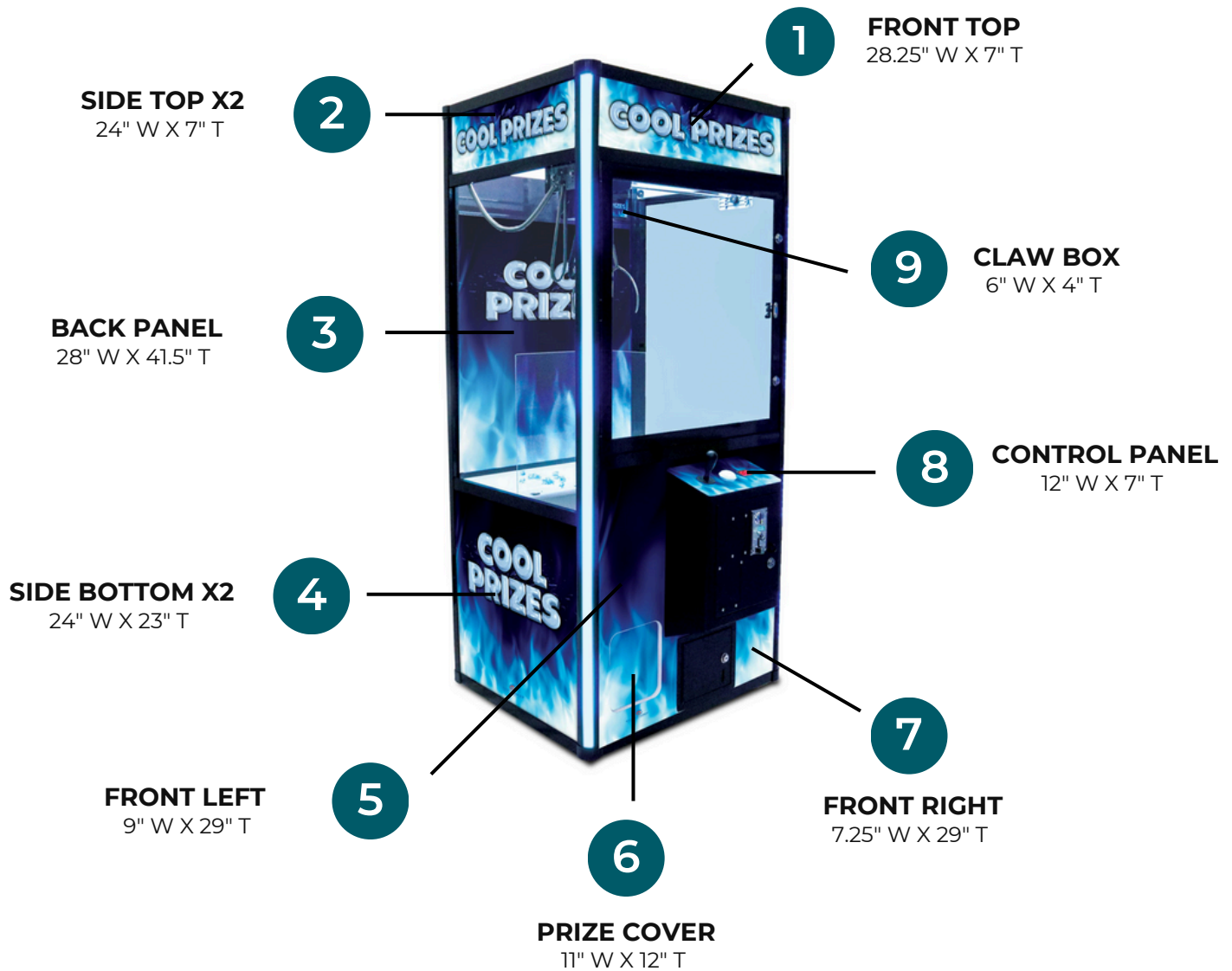

**ARCADES & GAMES
BRANDING GUIDES**

CRANE CLAW BRANDING GUIDE



THINGS TO KNOW



All grayscale and color art should be 300 DPI



Vector art saved as .EPS (fonts & images embedded or supplied)



We accept: Adobe PDF (fonts embedded) & Illustrator (EPS or AI) files



Web and low resolution images are not suitable

Please note: When sending multiple files they need to be seperated by page.

LED CORNHOLE BRANDING GUIDE

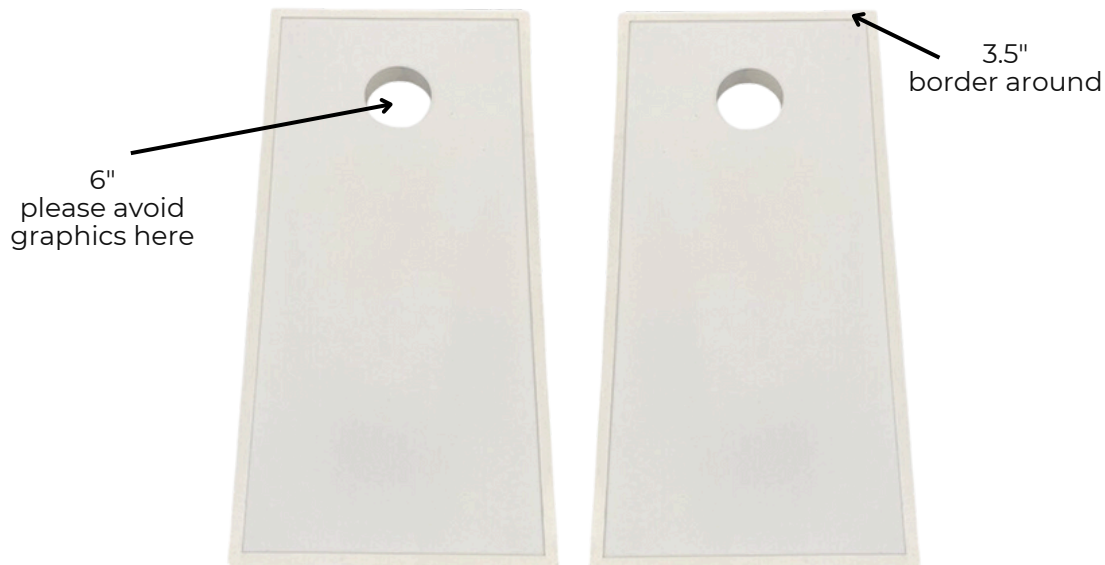

BOARD X2
2' W X 4' T

THINGS TO KNOW



All grayscale and color art should be 300 DPI



Vector art saved as .EPS (fonts & images embedded or supplied)



We accept: Adobe PDF (fonts embedded) & Illustrator (EPS or AI) files



Web and low resolution images are not suitable

Please note: When sending multiple files they need to be seperated by page.

WOOD CORBHOLE SET BRANDING GUIDE



BOARDS X2
24" W X 48" T

THINGS TO KNOW



All grayscale and color art should be 300 DPI



Vector art saved as .EPS (fonts & images embedded or supplied)



We accept: Adobe PDF (fonts embedded) & Illustrator (EPS or AI) files



Web and low resolution images are not suitable

Please note: When sending multiple files they need to be seperated by page.

NBA GAMETIME BRANDING GUIDE



1

RIGHT SIDE

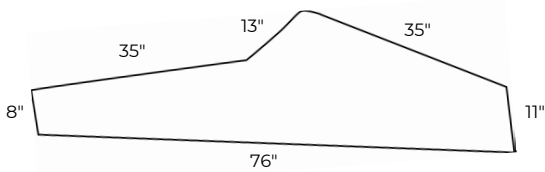
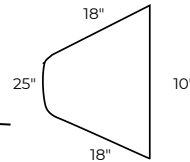
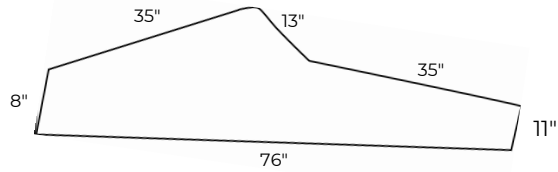

2

LEFT SIDE

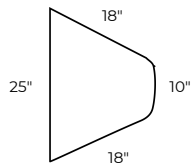

1

RIGHT SIDE

Measurements above

2

LEFT SIDE

Measurements above

THINGS TO KNOW



All grayscale and color art should be 300 DPI



Vector art saved as .EPS (fonts & images embedded or supplied)



We accept: Adobe PDF (fonts embedded) & Illustrator (EPS or AI) files



Web and low resolution images are not suitable

Please note: When sending multiple files they need to be seperated by page.

HALF COURT HOOPS BRANDING GUIDE



1

RIGHT SIDE

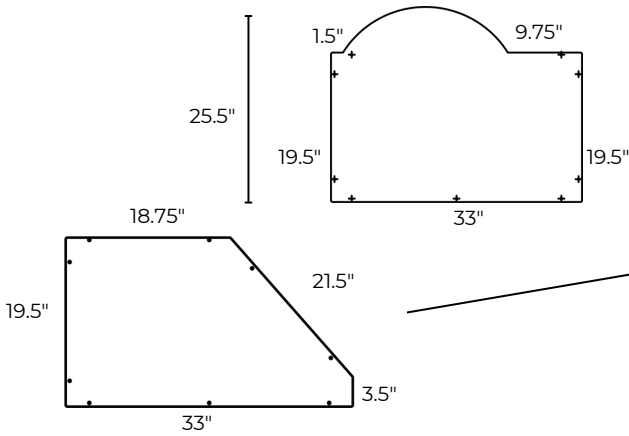
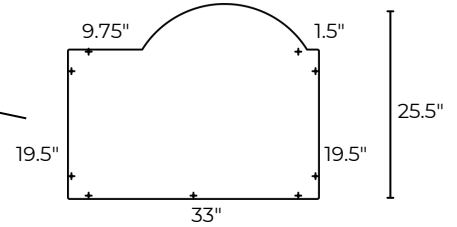
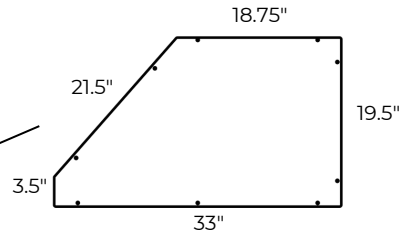

2

LEFT SIDE



1

RIGHT SIDE

Measurements above

2

LEFT SIDE

Measurements above

THINGS TO KNOW



All grayscale and color art should be 300 DPI



Vector art saved as .EPS (fonts & images embedded or supplied)



We accept: Adobe PDF (fonts embedded) & Illustrator (EPS or AI) files



Web and low resolution images are not suitable

Please note: When sending multiple files they need to be seperated by page.

FOOSBALL TABLE BRANDING GUIDE



1	2
LONG SIDE x2 47.125" W X 5.75" T	END SIDE x2 27.625" W X 10.25" T

THINGS TO KNOW



All grayscale and color art should be 300 DPI



Vector art saved as .EPS (fonts & images embedded or supplied)



We accept: Adobe PDF (fonts embedded) & Illustrator (EPS or AI) files



Web and low resolution images are not suitable

Please note: When sending multiple files they need to be seperated by page.

PING PONG TABLE BRANDING GUIDE



1
TOP - BOTH SIDES
48" W X 48" T

THINGS TO KNOW



All grayscale and color art should be 300 DPI



Vector art saved as .EPS (fonts & images embedded or supplied)



We accept: Adobe PDF (fonts embedded) & Illustrator (EPS or AI) files



Web and low resolution images are not suitable

Please note: When sending multiple files they need to be seperated by page.

GLOWING SHUFFLE BOARD BRANDING GUIDE

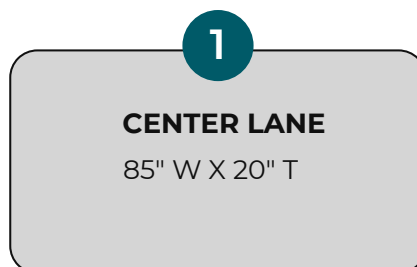
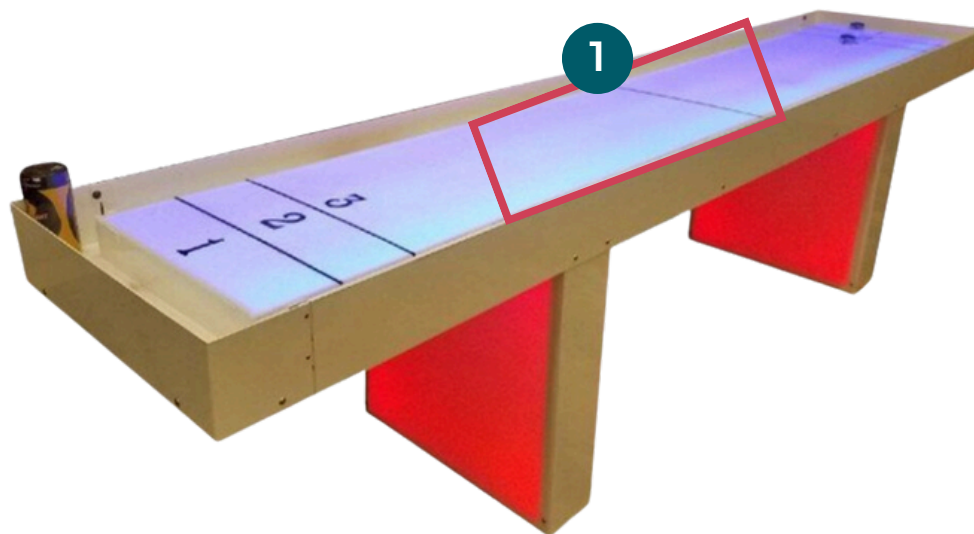

THINGS TO KNOW



All grayscale and color art should be 300 DPI



Vector art saved as .EPS (fonts & images embedded or supplied)



We accept: Adobe PDF (fonts embedded) & Illustrator (EPS or AI) files



Web and low resolution images are not suitable

Please note: When sending multiple files they need to be seperated by page.

LED PING PONG TABLE BRANDING GUIDE

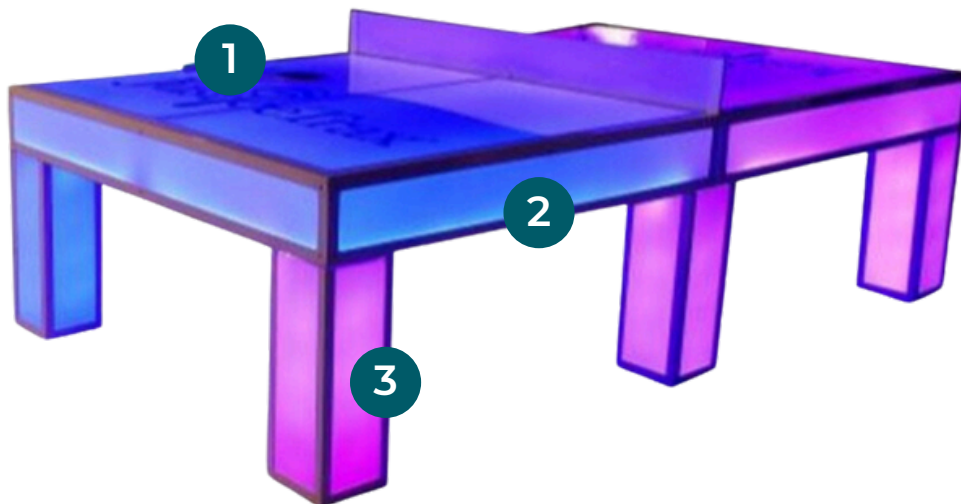

1

TOP ONLY OPTION
48" W X 48" T

2

SIDES X6
57" W x 5.5" T

3

LEGS X6
5" W x 21" T

THINGS TO KNOW



All grayscale and color art should be 300 DPI



Vector art saved as .EPS (fonts & images embedded or supplied)



We accept: Adobe PDF (fonts embedded) & Illustrator (EPS or AI) files



Web and low resolution images are not suitable

Please note: When sending multiple files they need to be seperated by page.

HYPER SHOOT BRANDING GUIDE



1

1

SIDE PANEL X2

28" W X 35" T

THINGS TO KNOW



All grayscale and color art should be 300 DPI



Vector art saved as .EPS (fonts & images embedded or supplied)



We accept: Adobe PDF (fonts embedded) & Illustrator (EPS or AI) files



Web and low resolution images are not suitable

Please note: When sending multiple files they need to be seperated by page.

ARCTIC AIR HOCKEY (FLAT TOP) BRANDING GUIDE



1

SIDE PANELS X2
86" W X 17" T

2

END PANELS X4
14" W X 17" T

THINGS TO KNOW



All grayscale and color art should be 300 DPI



Vector art saved as .EPS (fonts & images embedded or supplied)



We accept: Adobe PDF (fonts embedded) & Illustrator (EPS or AI) files



Web and low resolution images are not suitable

Please note: When sending multiple files they need to be seperated by page.

POOL TABLE BRANDING GUIDE

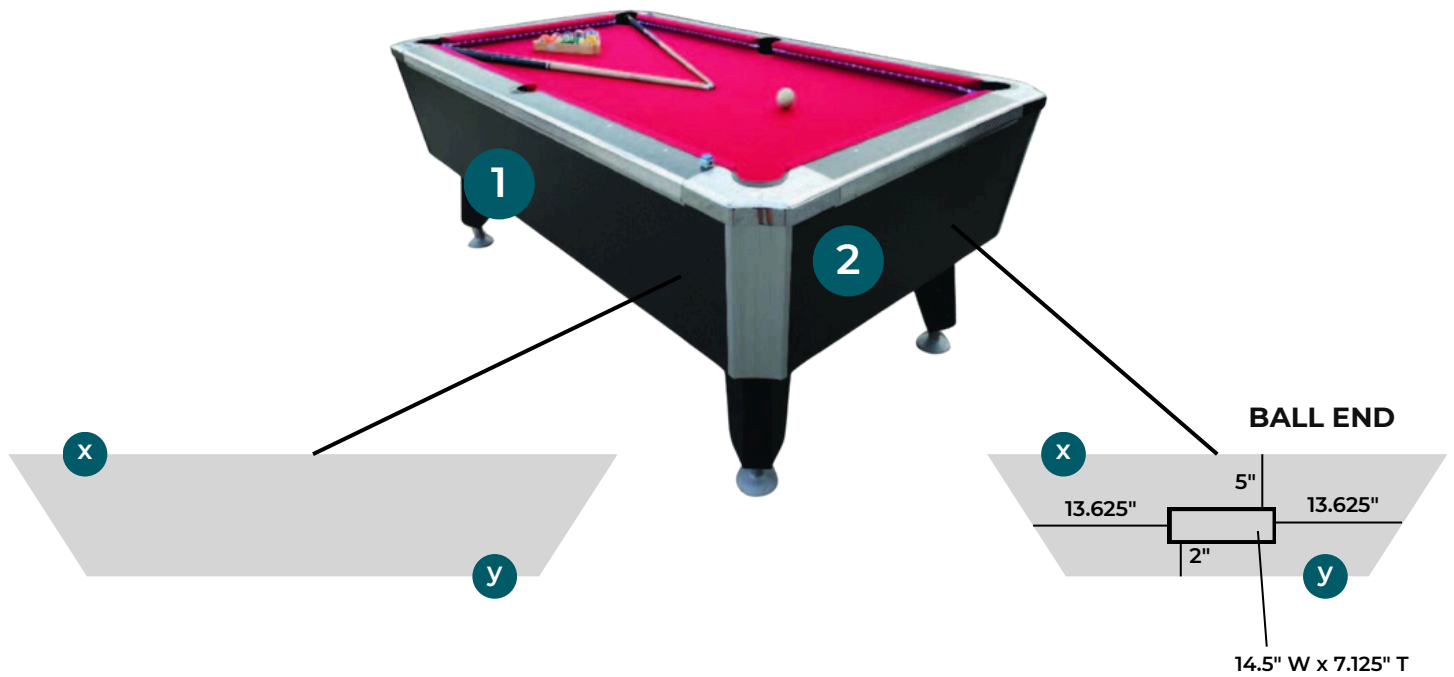

1

SIDE PANELS X2

X: 83.25" W X 15.125" T
Y: 79.875" W X 15.125" T

2

END PANELS X2

X: 43" W X 15.125" T
Y: 40.25" W X 15.125" T

THINGS TO KNOW



All grayscale and color art should be 300 DPI



Vector art saved as .EPS (fonts & images embedded or supplied)



We accept: Adobe PDF (fonts embedded) & Illustrator (EPS or AI) files



Web and low resolution images are not suitable

Please note: When sending multiple files they need to be seperated by page.